

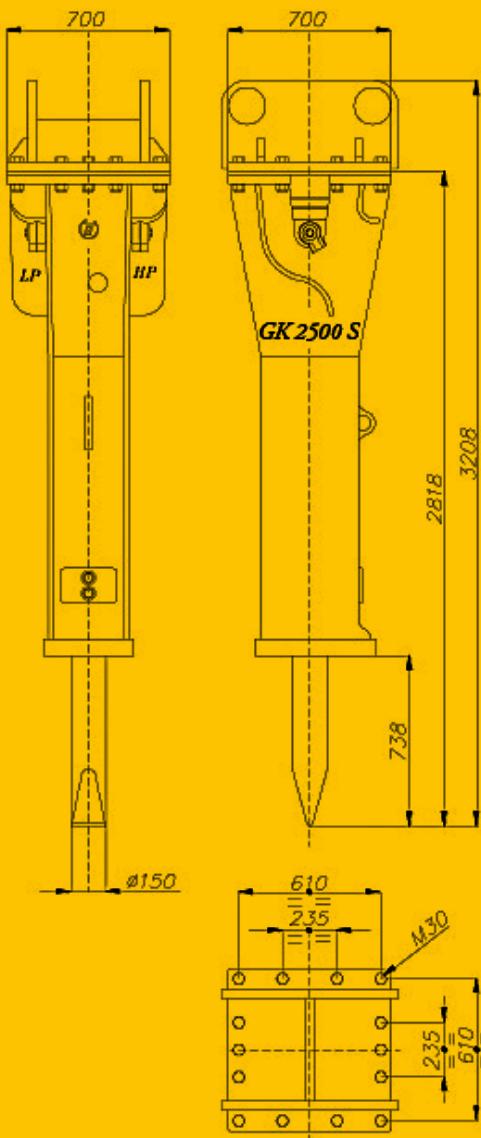

Italdem®



GK-2500 S HYDRAULIC BREAKER

OPERATING WEIGHT	2400 KG
TOOL DIAMETER	150 MM
OIL FLOW	220÷230 L/MIN
WORKING PRESSURE	140÷150 BAR
RELIEF VALVE	200 BAR
MAX BACKPRESSURE	12 BAR
BLOW ENERGY	5000 JOULE
REQUIRED POWER	78 HP
IMPACT RATE	550 (700)
CARRIER WEIGHT	28÷40 TON
MAX NOISE LEVEL (SILENCED)	88 DB-A
INNER DIAMETER HP LINE	32 MM
INNER DIAMETER LP LINE	38 MM

www.italdem.com